

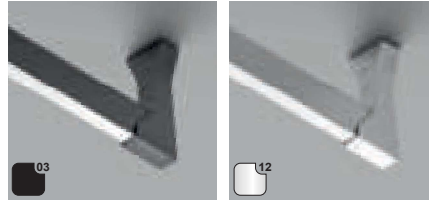

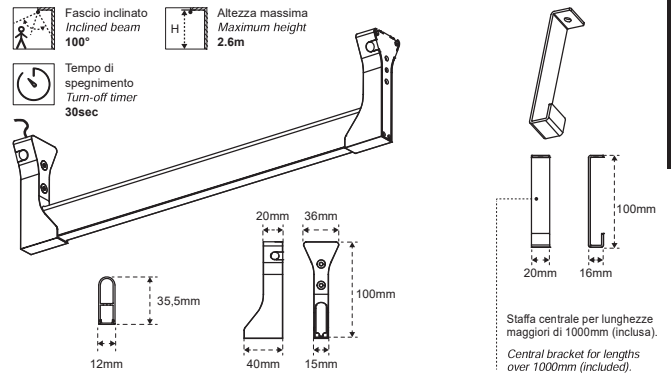





# Mec Rack



## MEC RACK PIR DX 12 V

24 V ON REQUEST

	13110870300AUD	6,2 W	540 mm	3000-4000K
	13110871200AUD			
	13110880300AUD	8,8 W	750 mm	3000-4000K
	13110881200AUD			
	13110890300AUD	10,4 W	870 mm	3000-4000K
	13110891200AUD			
	13110900300AUD	13 W	1050 mm	3000-4000K
	13110901200AUD			

## ACCESSORIES AND CONTROL



### PIR SENSOR

The motion sensor turns on the lamp when a presence is detected or when the door is opened. The lamp turns off after 30 seconds of inactivity.



### EMOTION DUAL COLOUR

The colour temperature varies from 'warm' to 'natural' white (3000-4000K). Emotion jumper integrated into the lamp.



### MEC DRIVER

For the selection of the power supply system go to page 262.